

CMT ORANGE TOOLS®

3D Router Carver System

CORNER OR ROSETTE CARVINGS



C.M.T. UTENSILI S.p.A.
Via della Meccanica
61122 Pesaro Italia
Tel. #39 0721 48571
Fax #39 0721 481021
info@cmtorangetools.com
www.cmtorangetools.com

CMT USA, Inc.
7609 Bentley Road Suite D
Greensboro, NC 27409
phone 336.854.0201
fax 336.854.0903
info@cmtusa.com
www.cmtorangetools.com

Includes templates for one of these designs:



Classical
RCS-602

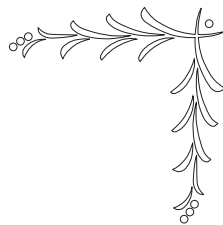

Florentine
RCS-604



Cascade
RCS-605



Folklore
RCS-606

Use these templates with Holding Frame #**RCS-006**

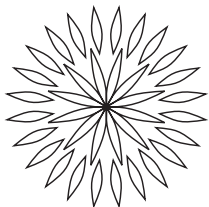

Rosette 1&5
RCS-701

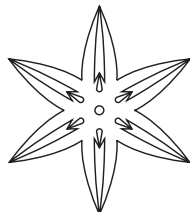

Rosette 2&6
RCS-702

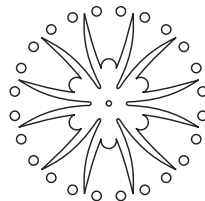

Rosette 3&7
RCS-703

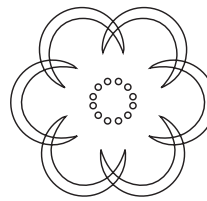

Rosette 4&8
RCS-704

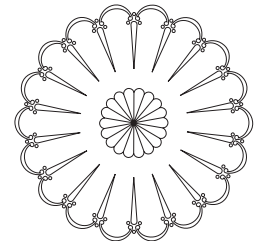

Rosette large
RCS-801

Rosette small
RCS-802

Please see label below for design in this package.

Please refer to back for instructions. Use these templates with Holding Frame #**RCS-007**



WARNING: Drilling, sawing, sanding or machining wood products can expose you to wood dust, a substance known to the State of California to cause cancer. Avoid inhaling wood dust or use a dust mask or other safeguards for personal protection. For more information go to www.P65Warnings.ca.gov/wood **WARNING:** This product can expose you to formaldehyde, which is known to the State of California to cause cancer. For more information go to www.P65Warnings.ca.gov



Made in Italy
Insert #RCS-INS03

BIT AND ROUTER SET UP

1. The 3D Router Carver bit includes a round set up jig (see the dotted line in Fig. 1). Adjust the bit so that the cutting edge is flush with this jig. This ensures that the routed grooves will be the correct depth. Adjust by loosening the locking nut and turning the cutter in or out as required. (In extremely hard wood it may be necessary to set the bit for a shallow first cut and then set to normal position for the finish cut.) The set up jig simulates the thickness of the templates and ensures that the cutting tip is just touching the workpiece to begin the carving.
2. Tighten the 3D Router Carver bit into your router collet and release the plunge mechanism, allowing smooth travel of the router along the plunge guides. Keep the router's plunge guides well-lubricated.

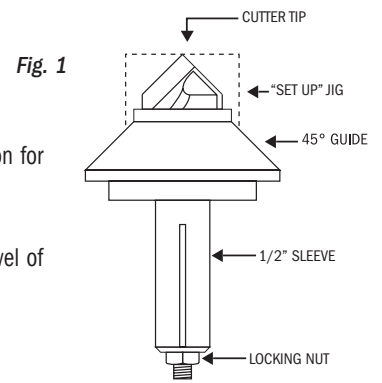

FRAME AND TEMPLATE SET UP

3. Select the required design templates and corresponding holding frame. Secure the holding frame to the workpiece by clamping or tacking (see Fig. 2).
4. Insert one template into the holding frame (there may be up to 4 templates per design). The templates are designed to fit tightly into the frame, and therefore NO separate clamping is required. (see Fig. 3)

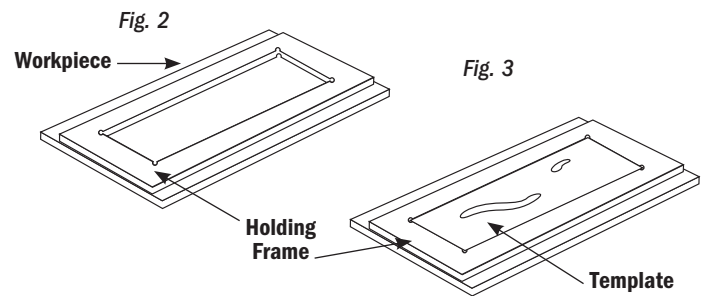

ROUTING TECHNIQUE

5. Start the router and position over the widest part of a slot. Plunge down until the cone shaped guide comes into contact with both edges of the slot, then move to the end of the slot. By plunging down at the widest part of the slot, the risk of the cutting edge coming into contact and damaging the template is reduced.
6. Make one pass through the entire length of the slot. This removes the bulk of the material. Follow up with a finishing pass. Repeat for all slots in the template.

Note: keep a slight downward pressure on the machine as it moves along the slot. The depth and width of the cut will be automatically controlled by the combination of the template and the cone shaped guide.

7. Once all cuts on the first side of the template have been completed, remove and realign the template as indicated in the following section.

CORNER DESIGN TEMPLATES (Fig 4)

1. Rout all slots in one side of the template
2. Flip the template and rout all slots again.
3. Repeat entire procedure for all templates in each design.

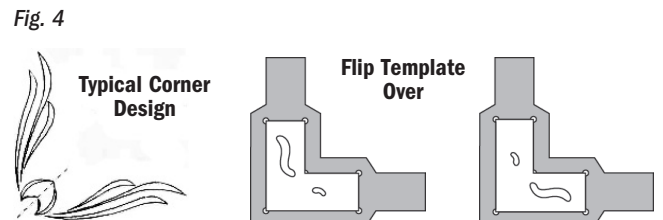

SIX-WAY SYMMETRICAL DESIGN (ROSETTES) (Fig. 5)

Note: rosette designs can be used separately or added to some of the standard designs. Rosettes 1, 2, 3, 4, can be used with the cabinet door holding frames as well as the rosette frames. Rosettes 5, 6, 7, 8, can be used with the rail frame or the rosette frame. In these designs each slot is used 6 times on each side. In other words, each slot is used for a total of 12 cuts.

1. Rout all slots in the template.
2. Rotate 60° so the next corner of the template is in the notches in the holding frame and rout all slots.
3. Repeat for all corners on this surface of the template.
4. Flip the template over and repeat the entire procedure.

Note: when adding rosette designs to the standard designs, it is advisable to leave the holding frame in position. This allows for perfect alignment of the rosette within the existing larger design.

Fig. 5

